

Doc. No.		Ouhui.OHBF8236B-2.	
Version:1.0	Audit No.: 0	In Total 8 Pages	1/8

PRODUCT SPECIFICATION



Model	OHBF8235	Formulate	Fengze Lv
Product name	LED Explosion Proof High-Bay Light	Proofreading	Ji Yang
Jiangsu Ouhui Lighting Co.,Ltd.		Review	Dongyang Wu
		Approve	Fengqi Yuan
		Date	1 st , June, 2020

Doc. No.		Ouhui.OHBF8236B-2.	
Version:1.0	Audit No.: 0	In Total 8 Pages	2/8

CONTENTS

1. Pictures	3
2. Features	4
3. Product parameters	5
4. Test Report	6
5. Dimensions	6
6. Install	7
7. Packaging Logistics	7
8. Caution	8

Doc. No.		Ouhui.OHBF8236B-2.	
Version:1.0	Audit No.: 0	In Total 8 Pages	3/8

1. Pictures



Doc. No.		Ouhui.OHBF8236B-2.	
Version:1.0	Audit No.: 0	In Total 8 Pages	4/8

2. Features

2.1 Applications

This product has good explosion-proof function, suitable for IIA, IIB, IIC explosive gas environment and various inflammable and explosive places, mainly used in railway, electric power, metallurgy, petroleum, petrochemical, chemical, steel, aviation, ship and each Efficient lighting in factories, stations, large facilities, venues and other places.

2.2 Product Features

2.2.1 It adopts imported LED light source, with an average service life of up to 100,000 hours. The power supply adopts wide voltage processing, which can realize constant current output, and has short-circuit and over-voltage protection functions, which greatly prolongs the service life of the lamps.

2.2.2 Independent up and down ventilation convection structure design, improve the heat dissipation performance at the same time to avoid the conventional LED radiator will accumulate dust phenomenon. The heat sink is arranged in an array of inner and outer circumferences to improve heat dissipation performance.

2.2.3 the use of high purity tempered glass, light transmittance of up to 95% -98%. The light projection is even and soft, especially suitable for various low-top, platform, high-top, high-shed and other places as fixed lighting.

2.2.4 The protection level of the lamp body is IP66, and the anti-corrosion level can reach WF2. The surface of the lamp body will never corrode and never rust.

2.2.5 Various installation methods such as ceiling, curved rod, vertical pole, ceiling, U-shaped anti-vibration bracket (angle adjustable) can be used as needed.

Doc. No.		Ouhui.OHBF8236B-2.	
Version:1.0	Audit No.: 0	In Total 8 Pages	5/8

3. Product parameters

Item	Symbol	Description	Unit
Picture			
Rated Voltage	VOLT	AC100-240	V
Power	P	200-280	W
Naked chip Lumen		150	Lm/W
Actual chip Lumen		120-130	Lm/W
Protection Level	IP	IP66	IP
Lighting Angle	θ	88	°
LED Qty	/	220	PCS
Base specifications	/	CREE3030	
Anti-corrosion grade	/	WF2	
Explosion proof grade	/	Ex d IIC T6	
Light efficiency	η	120	Lm/W
Frequency	f	50/60	Hz
Power Factor	PF	>0.95	PF
Operating Temperature	TOPR	-30~50	°C
Storage Temperature	TOPR	-30~50	°C
Light Source	/	led	PCS
Correlate Color Temperature	Tc	3000-6500	K
Color Rendering Index	CRI	≥70	RA
LED'S Operating Life	LIFE	100000	Hours
Start-up time	T	≤0.2	S
Executive standard	/	GB3836.1、 GB3836.2	
Weight	/	8.8	KG
Size	/	Φ415*351	MM

Doc. No.		Ouhui.OHBF8236B-2.	
Version:1.0	Audit No.: 0	In Total 8 Pages	6/8

4. Test Report

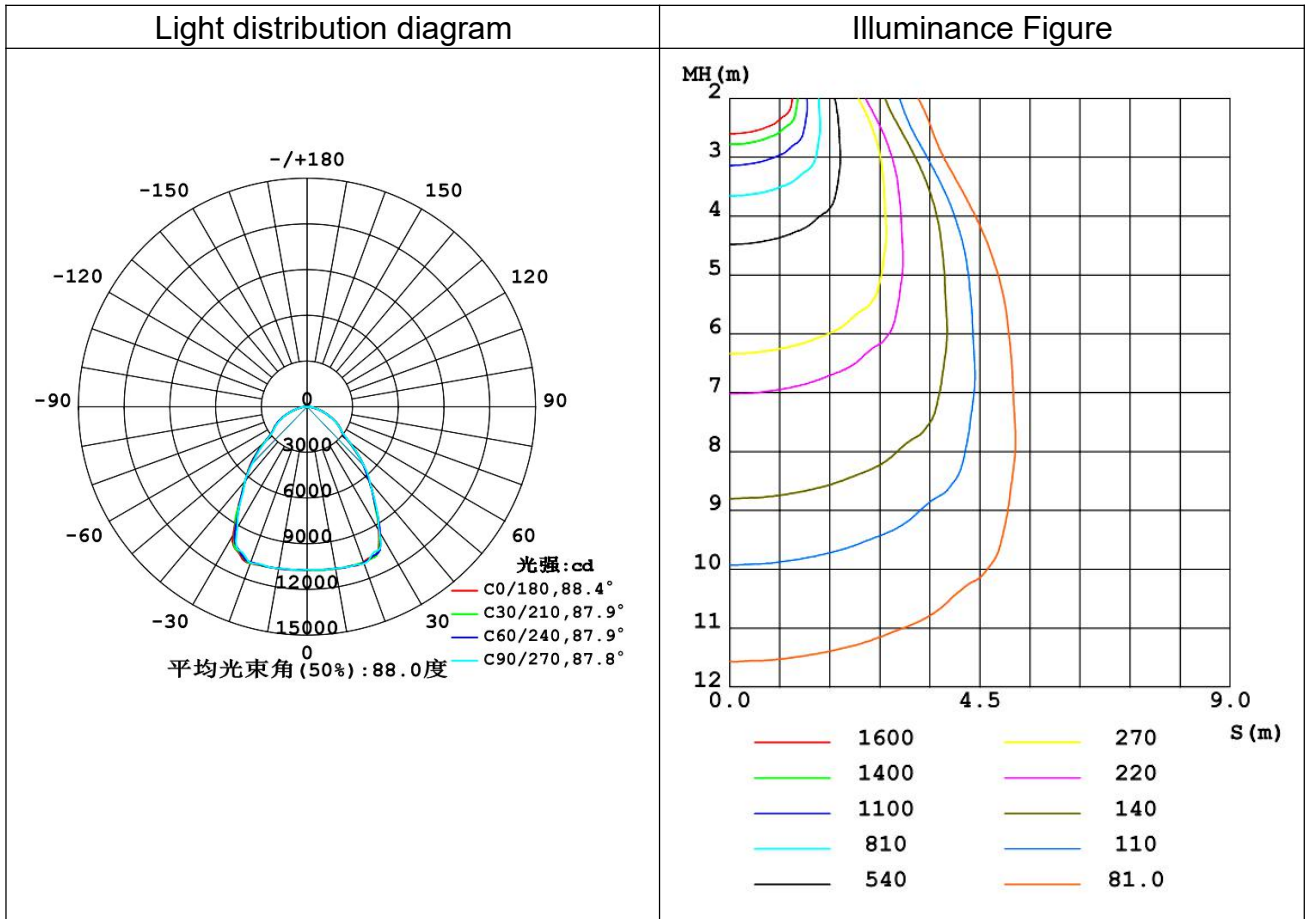

5. Dimensions

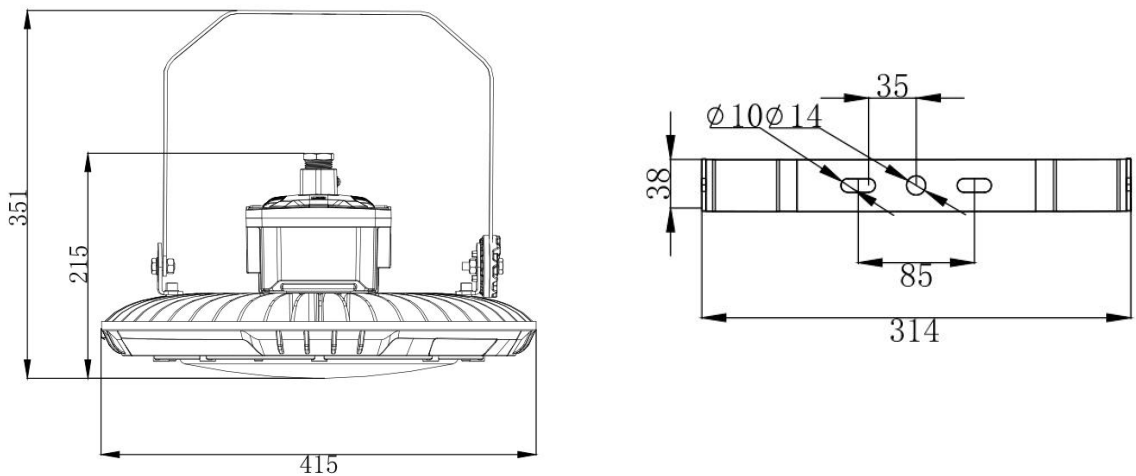

Doc. No.		Ouhui.OHBF8236B-2.	
Version:1.0	Audit No.: 0	In Total 8 Pages	7/8

6. Install

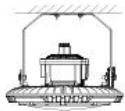

A-Ceiling Type

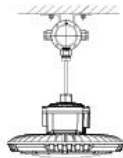

B-Tube Hanging Type

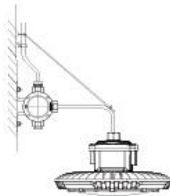

C-Wall Mount Type(1)

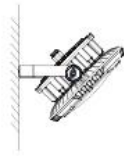

D-Wall Mount Type(2)

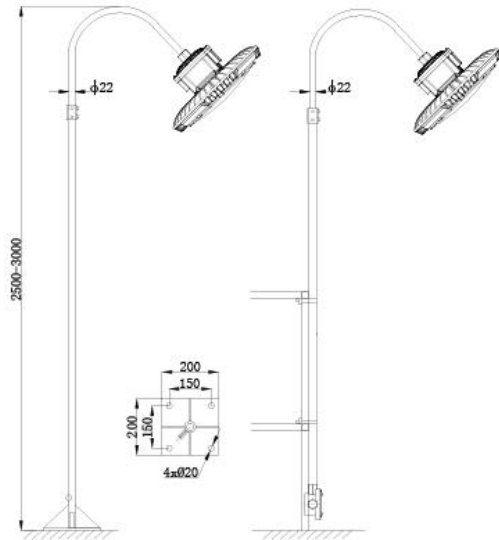

E-Flange Type

F-Fence Type

7. Packaging logistics

Name	Description	Quantity	Name	Parameter
Outer box	43.2*43.2*26.4cm 7-layer corrugated paper	1	N.W.	8.8kg
Foam	35.6*35.6*3cm	1	G.W.	10.5kg
Line foam	9.5*9.5*5.4cm	1		
Packaging method		1 pcs in 1 carton		



Doc. No.		Ouhui.OHBF8236B-2.	
Version:1.0	Audit No.: 0	In Total 8 Pages	8/8

8. Caution

8.1 Installation Intentions

8.1.1 Before installation, it is necessary to check whether the actual operating conditions are in conformity with the parameters listed on the lamp nameplate.

8.1.2 Before installation, please test the lighting according to the parameters of the lamp nameplate to ensure that there is no quality problem before installation.

8.1.3 Before installation, it is necessary to determine the installation location and mode of the lamps according to the installation mode provided by the product, in combination with the on-site use environment and lighting requirements, so as to ensure that the installation is firm and reliable.

8.1.4 Connect the prepared cables with the input cables of lamps and lanterns according to the corresponding fire (brown), zero (blue) and ground (yellow-green) wires, so as to ensure that the connection is firm, and make good insulation and waterproof measures at the connection.

8.1.5 The input end of the cable can be connected to the power supply of the corresponding voltage to illuminate.

8.2 Using Attentions

8.2.1 This product is an explosion-proof product and can be used in explosion-proof places.

8.2.2 When transporting, the lamp should be installed in the carton equipped with foam shock absorption.

8.2.3 When using, the surface of the lamp has a certain temperature rise, which is a normal phenomenon.

8.2.4 The power supply voltage can work normally in the rated voltage. If the power supply voltage is too high, the lamp will be damaged; if the voltage is too low, the lamp will not start normally.

8.2.5 The luminaire must be reliably grounded.

8.3 Quality Assurance

The company has passed ISO9001:2008 international quality system audit certification, this product strictly implements ISO9001 international quality management system standard production, to ensure that the product quality fully meets national standards and design requirements.